

# Data Sheet



Article number: 02140000031

Description: Sealing Clamp S 31 W1

## Measures

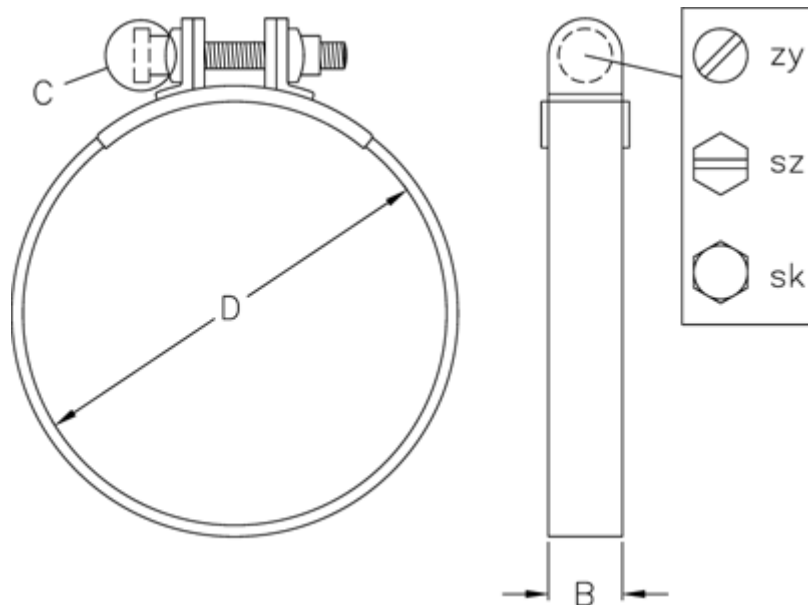

C (screw type) = SZ

Diameter D = 31

Width B = 15